

LOOK/LOOK FREE



EXCELLENT VALUE
WITH MANY TECHNICAL FEATURES

PROVEX
comfort in the bathroom

INDICE LOOK/LOOK FREE
 INHALT LOOK/LOOK FREE
 INDEX LOOK/LOOK FREE
 INDICE LOOK/LOOK FREE

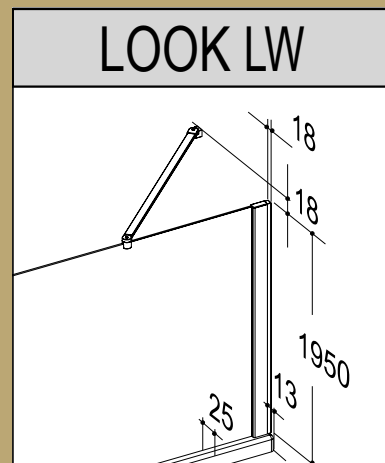
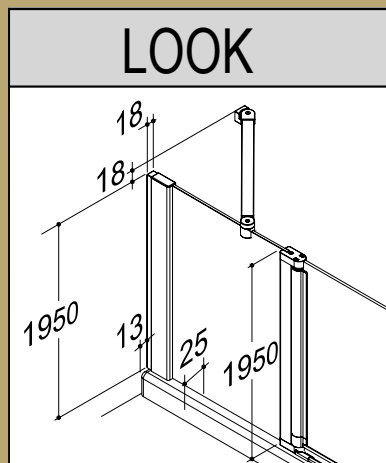
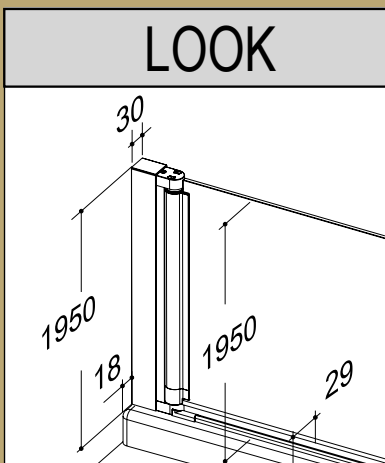
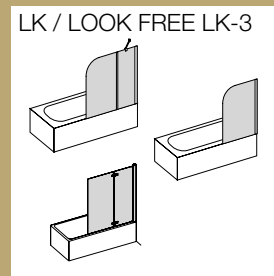
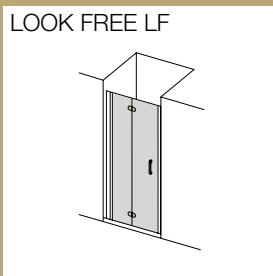
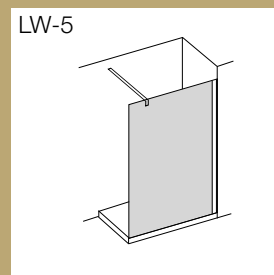
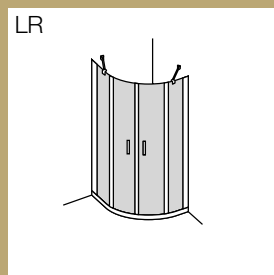
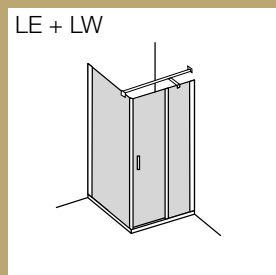
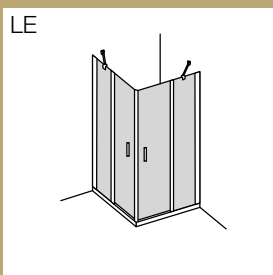
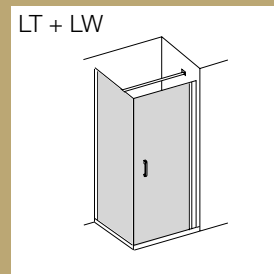
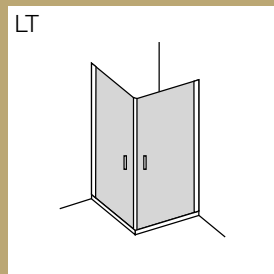
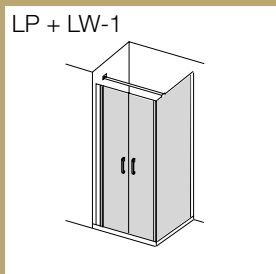
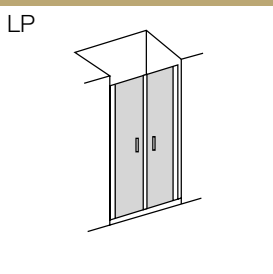
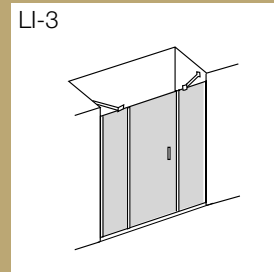
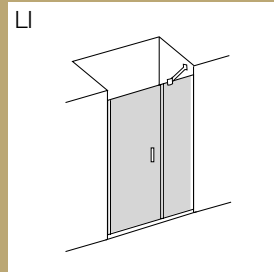
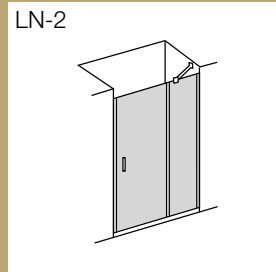
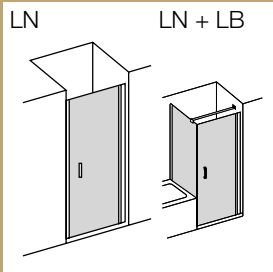



BOX CON PARZIALE TELAIO

- Design lineare e moderno senza profili orizzontali
- Ideale rapporto qualità-prezzo e vasta gamma di modelli
- Elementi porta basculante con meccanismo di sollevamento-abbassamento attivo
- Profilo a parete senza bisogno di silicone
- Estensibilità da 25-35 mm e vetro di sicurezza 6 mm
- Tenuta stagna testata a 11 litri/minuto
- Altezza continua della cabina 1950 mm (profilo e vetro)



TEILRAHMENKABINEN

- Lineares, modernes Design ohne Querverbinder
- Ideales Preis-Leistungsverhältnis und große Modellvielfalt
- Pendel-Türelemente mit aktivem Hebe-Senkmechanismus
- Silikonfreier Wandanschluss
- Verstellbereich von 25 – 35 mm und 6 mm Sicherheitsglas
- Getestete Wasserdichtheit von 11 Liter/Minute
- Durchgehende Kabinenhöhe 1950 mm (Profil und Glas)

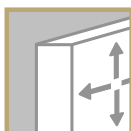

PARTIAL FRAMED SHOWER ENCLOSURE

- Linear, modern design without horizontal profiles
- Ideal price-performance ratio and wide range of models
- Saloon door elements with active rise and fall lifting mechanism
- Silicone-free wall junction
- Adjustment range 25-35 mm and 6 mm safety glass
- Tested to be watertight to 11 litres per minute
- Continuous cabin height 1950 mm (profile and glass)



CABINA CON PERFIL PARCIAL

- Diseño lineal y moderno sin perfil horizontal
- Buena relación calidad-precio y una amplia gama de modelos
- Mecanismo de puerta basculante de levantamiento/descenso permanente
- Fijación a pared sin necesidad de silicona
- Extensibilidad de 25 a 35 mm y vidrio de seguridad de 6 mm
- Estanqueidad para un caudal máximo 11 litros/ minuto
- Altura de la mampara 1950 mm (perfil + vidrio)

LOOK LN + LB

ENTRATA FRONTALE + LATERALE PER VASCA
FRONTEINSTIEG + SEITENWAND FÜR BADEWANNE
FRONT ENTRY + SIDE PANEL FOR BATHTUB
ENTRADA FRONTAL + PARED PARA BAÑERA





High
GLASS



LN 1950 LB max.1800

OH High Glass GH High Glass SC OG GL 6mm

28 05

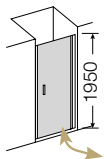
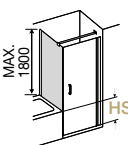
| Descrizione Articolo Artikelbezeichnung Model description Descripción artículo | Articolo Artikel Model Código | Misura piatto doccia Tassenmaß Tray size Medidas del plato mm | Estensibilità Verstellbarkeit Adjustability Extensibilidad mm | Misura Maß Size Medidas mm | | |
|--|--|---|---|--|-----|--|
| | | | | A | B | |
|  Porta basculante singola Pendeltür 1-teilig Saloon door single Puerta basculante | 0001 LN | 700 | 668 - 703 | 590 | 620 | |
| | 0002 LN | 750 | 718 - 753 | 640 | 670 | |
| | 0003 LN | 800 | 768 - 803 | 690 | 720 | |
| | 0004 LN | 900 | 868 - 903 | 790 | 820 | |
| | 0005 LN | 1000 | 968 - 1003 | 890 | 920 | |
|  Laterale per vasca Seitenteil für Badewanne Side panel for bathtub Pared lateral para bañera | 0015 LB* | 700 - 1000 | 25 | | | |
| | | | | | | |
| | | | | | | |
| | | | | | | |
| | | | | | | |

* Articolo é sempre un fuori misura / Artikel ist immer Sondermaß / article is always special measure / artículo es siempre medida especial



Indicare sempre bordo piatto fino bordo vasca/muretto
 Oberkante Duschtasse bis Badewanne/Mauer immer angeben
 Indicate always shower tray to bathtub panel/wall
 Indique siempre borde superior plato de ducha y bañera/muro

LOOK LN-2 + LB

PORTA CON FISSO IN LINEA + LATERALE PER VASCA

TÜR MIT FESTFELD IN LINIE + SEITENWAND FÜR BADEWANNE

PIVOT DOOR WITH IN-LINE FIXED PANEL + SIDE PANEL FOR BATHTUB

PUERTA CON LATERAL FIJO + PARED PARA BAÑERA





High
GLASS



LN-2 1950 LB max.1800

OH High Glass GH High Glass SC OG GL 6mm

28 05

| Descrizione Articolo Artikelbezeichnung Model description Descripción artículo | Articolo Artikel Model Código | Misura piatto doccia Tassenmaß Tray size Medidas del plato mm | Estensibilità Verstellbarkeit Adjustability Extensibilidad mm | Misura Maß Size Medidas mm | | |
|---|--|---|---|--|-----|--|
| | | | | A | B | |
| <p>Porta basculante in linea Pendeltür mit Festfeld in Linie Saloon door with in-line fixed panel Puerta basculante con lateral fijo</p> | 2004 LN | 900 | 870 - 905 | 565 | 310 | |
| | 2005 LN | 1000 | 970 - 1005 | 565 | 410 | |
| | 2006 LN | 1100 | 1070 - 1105 | 665 | 410 | |
| | 2007 LN | 1200 | 1170 - 1205 | 665 | 510 | |
| | 2009 LN | 1400 | 1370 - 1405 | 665 | 710 | |
| <p>Laterale per vasca Seitenteil für Badewanne Side panel for bathtub Pared lateral para bañera</p> | 0015 LB* | 700 - 1000 | 25 | | | |
| | | | | | | |
| | | | | | | |
| | | | | | | |
| | | | | | | |

* Articolo é sempre un fuori misura / Artikel ist immer Sondermaß / article is always special measure / artículo es siempre medida especial

| | |
|--|--|
| | <p>Bordo piatto fino bordo vasca/muretto Oberkante Duschtasse bis Badewanne/Mauer Shower tray to bathtub panel/wall Borde superior plato de ducha y bañera/muro</p> |
|--|--|

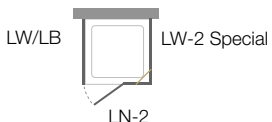

LOOK LI

PORTA CON FISSO IN LINEA

TÜR MIT FESTFELD IN LINIE

PIVOT DOOR WITH IN-LINE FIXED PANEL

PUERTA CON LATERAL FIJO





High
GLASS



LI
1950

OH High Glass GH High Glass SC OG GL 6 mm

28 05

| Descrizione Articolo Artikelbezeichnung Model description Descripción artículo | Articolo Artikel Model Código | Misura piatto doccia Tassenmaß Tray size Medidas del plato mm | Estensibilità Verstellbarkeit Adjustability Extensibilidad mm | Misura Maß Size Medidas mm |
|---|--|---|---|--|
| <p>Porta basculante in linea Pendeltür mit Festfeld in Linie Saloon door with in-line fixed panel Puerta basculante con lateral fijo</p> | 0005 LI | 1000 | 955 - 1005 | 330 590 620 |
| | 0006 LI | 1100 | 1055 - 1105 | 330 690 720 |
| | 0007 LI | 1200 | 1155 - 1205 | 330 790 820 |
| | 0009 LI | 1400 | 1355 - 1405 | 530 790 820 |
| | | | | |

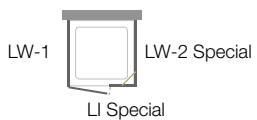

LOOK LI-3

PORTA CON LATERALI IN LINEA

TÜR MIT SEITENWÄNDEN IN LINIE

PIVOT DOOR WITH IN-LINE FIXED PANELS

PUERTA CON LATERALES FIJO





| | | | | | |
|------------------|------------------|----|----|----|------|
| OH High Glass | GH High Glass | SC | OG | GL | 6 mm |
|------------------|------------------|----|----|----|------|

| | | |
|----|----|--|
| 28 | 05 | |
|----|----|--|

| Descrizione Articolo Artikelbezeichnung Model description Descripción artículo | Articolo Artikel Model Código | Misura piatto doccia Tassenmaß Tray size Medidas del plato mm | Estensibilità Verstellbarkeit Adjustability Extensibilidad mm | Misura Maß Size Medidas mm | | | | | | | | |
|--|--|---|---|---|---|---|---|-----|-----|-----|-----|-----|
| <p>Porta con laterali in linea Tür mit Seitenwänden in Linie Pivot door with in-line fixed panels Puerta con laterales fijo</p> | 3120 LI | 1200 | 1153 - 1203 | <table border="1"> <tr> <td>A</td> <td>B</td> <td>C</td> <td>D</td> </tr> <tr> <td>305</td> <td>560</td> <td>560</td> <td>310</td> </tr> </table> | A | B | C | D | 305 | 560 | 560 | 310 |
| | A | B | C | D | | | | | | | | |
| | 305 | 560 | 560 | 310 | | | | | | | | |
| | 3140 LI | 1400 | 1353 - 1403 | <table border="1"> <tr> <td>A</td> <td>B</td> <td>C</td> <td>D</td> </tr> <tr> <td>405</td> <td>660</td> <td>660</td> <td>310</td> </tr> </table> | A | B | C | D | 405 | 660 | 660 | 310 |
| A | B | C | D | | | | | | | | | |
| 405 | 660 | 660 | 310 | | | | | | | | | |
| 3160 LI | 1600 | 1553 - 1603 | <table border="1"> <tr> <td>A</td> <td>B</td> <td>C</td> <td>D</td> </tr> <tr> <td>505</td> <td>660</td> <td>660</td> <td>410</td> </tr> </table> | A | B | C | D | 505 | 660 | 660 | 410 | |
| A | B | C | D | | | | | | | | | |
| 505 | 660 | 660 | 410 | | | | | | | | | |
| | | | | | | | | | | | | |



LOOK LP + LB-1

PORTA BASCULANTE
PENDELTÜR
SALOON DOOR
PUERTA BASCULANTE





High
GLASS



LB-1 **LP**
max.1800 1950



OH **GH** **SC** **OG** **GL** 6 mm
High Glass High Glass

28 **05**

| Descrizione Articolo Artikelbezeichnung Model description Descripción artículo | Articolo Artikel Model Código | Misura piatto doccia Tassenmaß Tray size Medidas del plato mm | Estensibilità Verstellbarkeit Adjustability Extensibilidad mm | Misura Maß Size Medidas mm A |
|--|--|---|---|---|
| <p>Porta basculante doppia Pendeltür 2-teilig Saloon door double Puerta basculante doble</p> | 0001 LP | 700 | 657 - 707 | 540 |
| | 0002 LP | 750 | 707 - 757 | 590 |
| | 0003 LP | 800 | 757 - 807 | 640 |
| | 0004 LP | 900 | 857 - 907 | 740 |
| | 0005 LP | 1000 | 957 - 1007 | 840 |
| | 0007 LP | 1200 | 1157 - 1207 | 1040 |
| <p>Laterale per vasca Seitenteil für Badewanne Side panel for bathtub Pared lateral para bañera</p> | 1015 LB* | 700 - 1000 | 25 | |
| | | | | |
| | | | | |
| | | | | |

* Articolo é sempre un fuori misura / Artikel ist immer Sondermaß / article is always special measure / artículo es siempre medida especial

| | |
|--|--|
| | <p>Bordo piatto fino bordo vasca/muretto Oberkante Duschtasse bis Badewanne/Mauer Shower tray to bathtub panel/wall Borde superior plato de ducha y bañera/muro</p> |
|--|--|

LOOK LP + LW-1

PORTA BASCULANTE CON LATERALE

PENDELTÜR MIT SEITENTEIL

SALOON DOOR WITH SIDE PANEL

PUERTA BASCULANTE CON LATERAL





High
GLASS



LP 1950 LW-1 1950

OH High Glass GH High Glass SC OG GL 6mm

28 05

| Descrizione Articolo Artikelbezeichnung Model description Descripción artículo | Articolo Artikel Model Código | Misura piatto doccia Tassenmaß Tray size Medidas del plato mm | Estensibilità Verstellbarkeit Adjustability Extensibilidad mm | Misura centro vetro Mitte Glasmaß Glass size middle Medida vidrio centro mm | Misura Maß Size Medidas mm A | |
|--|--|---|---|---|---|--|
| <p>Porta basculante doppia Pendeltür 2-teilig Saloon door double Puerta basculante doble</p> | 0001 LP | 700 | 677 - 727 | 662 - 712 | 540 | |
| | 0002 LP | 750 | 727 - 777 | 712 - 762 | 590 | |
| | 0003 LP | 800 | 777 - 827 | 762 - 812 | 640 | |
| | 0004 LP | 900 | 877 - 927 | 862 - 912 | 740 | |
| | 0005 LP | 1000 | 977 - 1027 | 962 - 1012 | 840 | |
| | 0007 LP | 1200 | 1177 - 1227 | 1162 - 1212 | 1040 | |
| <p>Laterale per porta basculante Seitenwand für Pendeltür Side panel for saloon door Lateral para puerta basculante</p> | 1001 LW | 700 | 670 - 695 | 655 - 680 | | |
| | 1002 LW | 750 | 720 - 745 | 705 - 730 | | |
| | 1003 LW | 800 | 770 - 795 | 755 - 780 | | |
| | 1004 LW | 900 | 870 - 895 | 855 - 880 | | |
| | 1005 LW | 1000 | 970 - 995 | 955 - 980 | | |

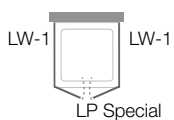

LOOK LT

BOX AD ANGOLO
ECKEINSTIEG
CORNER ENTRY
CABINA ANGULAR



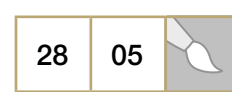

| Descrizione Articolo Artikelbezeichnung Model description Descripción artículo | Articolo Artikel Model Código | Misura piatto doccia Tassenmaß Tray size Medidas del plato mm | Estensibilità Verstellbarkeit Adjustability Extensibilidad mm | Misura centro vetro Mitte Glasmaß Glass size middle Medida vidrio centro mm | Misura Maß Size Medidas mm A |
|---|--|---|---|---|---|
| <p>Box ad angolo* EckEinstieg* Corner entry* Cabina angular*</p> | 0001 LT | 700 | 668 - 693 | 653 - 678 | 840 |
| | 0002 LT | 750 | 718 - 743 | 703 - 728 | 910 |
| | 0003 LT | 800 | 768 - 793 | 753 - 778 | 980 |
| | 0004 LT | 900 | 868 - 893 | 853 - 878 | 1125 |
| | 0005 LT | 1000 | 968 - 993 | 953 - 978 | 1265 |

*Usate 2 articoli LT per il box completo / Verwenden Sie 2 x Artikel LT für die komplette Kabine / Use 2 article LT for the complete box / Le rogamos de usar 2 x LT per para la cabina completa

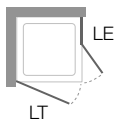

LOOK LT + LW

PORTA PIVOT CON LATERALE
SCHWINGTÜR MIT SEITENTEIL
PIVOT DOOR WITH SIDE PANEL
PUERTA PIVOTANTE CON LATERAL





High
GLASS



LT 1950 **LW** 1950

OH High Glass **GH** High Glass **SC** **OG** **GL** 6 mm

28 **05**

| Descrizione Articolo Artikelbezeichnung Model description Descripción artículo | Articolo Artikel Model Código | Misura piatto doccia Tassenmaß Tray size Medidas del plato mm | Estensibilità Verstellbarkeit Adjustability Extensibilidad mm | Misura centro vetro Mitte Glasmaß Glass size middle Medida vidrio centro mm | Misura Maß Size Medidas mm A B | |
|---|--|---|---|---|---|-----|
| <p>Porta basculante Pendeltür Saloon door Puerta basculante</p> | 0001 LT | 700 | 670 - 695 | 655 - 680 | 590 | 620 |
| | 0002 LT | 750 | 720 - 745 | 705 - 730 | 640 | 670 |
| | 0003 LT | 800 | 770 - 795 | 755 - 780 | 690 | 720 |
| | 0004 LT | 900 | 870 - 895 | 855 - 880 | 790 | 820 |
| | 0005 LT | 1000 | 970 - 995 | 955 - 980 | 890 | 920 |
| <p>Laterale con sostegno Seitenwand mit Stütze Side panel with support Pared lateral con soporte</p> | 0001 LW | 700 | 670 - 695 | 655 - 680 | | |
| | 0002 LW | 750 | 720 - 745 | 705 - 730 | | |
| | 0003 LW | 800 | 770 - 795 | 755 - 780 | | |
| | 0004 LW | 900 | 870 - 895 | 855 - 880 | | |
| | 0005 LW | 1000 | 970 - 995 | 955 - 980 | | |
| | 0006 LW | 1100 | 1070 - 1095 | 1055 - 1080 | | |
| | 0007 LW | 1200 | 1170 - 1195 | 1155 - 1180 | | |

LOOK LE

BOX AD ANGOLO
ECKKABINE
CORNER ENTRY
CABINA ANGULAR





| Descrizione Articolo Artikelbezeichnung Model description Descripción artículo | Articolo Artikel Model Código | Misura piatto doccia Tassenmaß Tray size Medidas del plato mm | Estensibilità Verstellbarkeit Adjustability Extensibilidad mm | Misura centro vetro Mitte Glasmaß Glass size middle Medida vidrio centro mm | Misura Maß Size Medidas mm | | |
|---|--|---|---|---|--|-----|-----|
| | | | | | A | B | C |
|  <p>Box ad angolo* Eckkabine* Corner entry* Cabina angular*</p> | 0001 LE | 700 | 665 - 690 | 650 - 675 | 540 | 380 | 310 |
| | 0002 LE | 750 | 715 - 740 | 700 - 725 | 610 | 430 | 310 |
| | 0003 LE | 800 | 765 - 790 | 750 - 775 | 660 | 480 | 310 |
| | 0004 LE | 900 | 865 - 890 | 850 - 875 | 800 | 580 | 310 |
| | 0005 LE | 1000 | 965 - 990 | 950 - 975 | 940 | 680 | 310 |
| | 0006 LE | 1100 | 1065 - 1090 | 1050 - 1075 | 940 | 680 | 410 |
| | 0007 LE | 1200 | 1165 - 1190 | 1150 - 1175 | 940 | 680 | 510 |

*Usate 2 articoli LE per il box completo / Verwenden Sie 2 x Artikel LE für die komplette Kabine / Use 2 article LE for the complete box / Le rogamos de usar 2 x LE per para la cabina completa

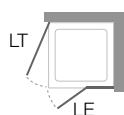

LOOK LE + LW

PORTA CON FISSO E LATERALE

TÜR MIT FESTFELD UND SEITENTEIL

DOOR WITH FIX PANEL AND SIDE PANEL

PUERTA CON FIJO Y PARED LATERAL





| | | |
|------------|------------|--|
| LE 1950 | LW 1950 | |
|------------|------------|--|

| | | | | | |
|------------------|------------------|----|----|----|------|
| OH High Glass | GH High Glass | SC | OG | GL | 6 mm |
|------------------|------------------|----|----|----|------|

| | | |
|----|----|--|
| 28 | 05 | |
|----|----|--|

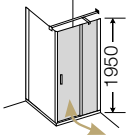
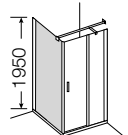
| Descrizione Articolo Artikelbezeichnung Model description Descripción artículo | Articolo Artikel Model Código | Misura piatto doccia Tassenmaß Tray size Medidas del plato mm | Estensibilità Verstellbarkeit Adjustability Extensibilidad mm | Misura centro vetro Mitte Glasmaß Glass size middle Medida vidrio centro mm | Misura Maß Size Medidas mm | | |
|---|--|---|---|---|--|-----|--|
| | | | | | A | B | |
|  Porta basculante con fisso* Pendeltür mit Festfeld* Saloon door with fix panel* Puerta basculante con fijo* | 0001 LE | 700 | 670 - 695 | 655 - 680 | 365 | 310 | |
| | 0002 LE | 750 | 720 - 745 | 705 - 730 | 415 | 310 | |
| | 0003 LE | 800 | 770 - 795 | 755 - 780 | 465 | 310 | |
| | 0004 LE | 900 | 870 - 895 | 855 - 880 | 565 | 310 | |
| | 0005 LE | 1000 | 970 - 995 | 955 - 980 | 665 | 310 | |
| | 0006 LE | 1100 | 1070 - 1095 | 1055 - 1080 | 665 | 410 | |
| | 0007 LE | 1200 | 1170 - 1195 | 1155 - 1180 | 665 | 510 | |
|  Laterale con sostegno Seitenwand mit Stütze Side panel with support Pared lateral con soporte | 0001 LW | 700 | 670 - 695 | 655 - 680 | | | |
| | 0002 LW | 750 | 720 - 745 | 705 - 730 | | | |
| | 0003 LW | 800 | 770 - 795 | 755 - 780 | | | |
| | 0004 LW | 900 | 870 - 895 | 855 - 880 | | | |
| | 0005 LW | 1000 | 970 - 995 | 955 - 980 | | | |
| | 0006 LW | 1100 | 1070 - 1095 | 1055 - 1080 | | | |
| | 0007 LW | 1200 | 1170 - 1195 | 1155 - 1180 | | | |

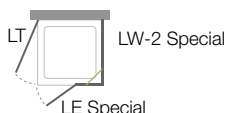
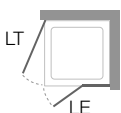

LOOK LR

BOX ROTONDO

RUNDKABINE

SHOWER ENCLOSURE CUBICLE

CABINA SEMICIRCULAR





High
GLASS



LR
1950

GH
High
GLASS

GL

6 mm

28

05



| Descrizione Articolo Artikelbezeichnung Model description Descripción artículo | Articolo Artikel Model Código | Misura piatto doccia Tassenmaß Tray size Medidas del plato mm | Estensibilità Verstellbarkeit Adjustability Extensibilidad mm | Misura piatto installato Tasseneinbaumaß Tray installation measure Medidas del plato instalado mm | Misura Maß Size Medidas mm | | |
|---|--|---|---|---|--|-----|-----|
| | | | | | A | B | C |
|  <p>Box rotondo* Rundkabine* Shower enclosure cubicle* Cabina semicircular*</p> | 6003 LR | 800 R 550 | 770 - 795 | 780 - 805 | 620 | 270 | 350 |
| | 6004 LR | 900 R 550 | 870 - 895 | 880 - 905 | 620 | 370 | 350 |
| | 6005 LR | 1000 R 550 | 970 - 995 | 980 - 1005 | 620 | 470 | 350 |
| | | | | | | | |

*Usate 2 articoli LR per il box completo / Verwenden Sie 2 x Artikel LR für die komplette Kabine / Use 2 article LR for the complete box / Le rogamos de usar 2 x LR per para la cabina completa

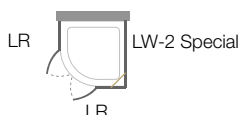
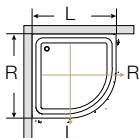

LOOK LW-5

PARETE DOCCIA CON SOSTEGNO
RAUMABTRENNUNG MIT STÜTZE
SHOWER SCREEN WITH SUPPORT
SEPARA EL ESPACIO CON APOYO



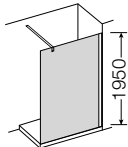

| Descrizione Articolo Artikelbezeichnung Model description Descripción artículo | Articolo Artikel Model Código | Misura Maß Size Medidas mm A | Estensibilità Verstellbarkeit Adjustability Extensibilidad mm A B | | Misura Maß Size Medidas mm A B |
|---|--|---|--|-------------|---|
| | | | A | B | |
|  <p>Parete doccia con sostegno Raumabtrennung mit Stütze Shower screen with support Separa el espacio con apoyo</p> | 5005 LW | 1000 | 985 - 1010 | 450 - 1200* | |
| | 5007 LW | 1200 | 1185 - 1210 | 450 - 1200* | |
| | 5009 LW | 1400 | 1385 - 1410 | 450 - 1200* | |
| | 5037 LW | SPECIAL | 600 - 1209 | 450 - 1200* | |
| | 5079 LW | SPECIAL | 1210 - 1410 | 450 - 1200* | |
| | | | | | |

* Sostegno può essere montato anche a 45°/Stütze kann auch diagonal montiert werden/support can be installed diagonal/ Apoyo también puede ser montado en diagonal



LOOK LK

ANTINA PER VASCA
KLAPPWAND FÜR BADEWANNE
PIVOTING BATHSCREEN
HOJA PARA BAÑERA





High
GLASS



LK
1400



| | | | | | |
|------------------|------------------|----|----|----|------|
| OH High Glass | GH High Glass | SC | OG | GL | 6 mm |
|------------------|------------------|----|----|----|------|

| | | |
|----|----|--|
| 28 | 05 | |
|----|----|--|

| Descrizione Articolo Artikelbezeichnung Model description Descripción artículo | Articolo Artikel Model Código | Misura vasca Wannenmaß Bathtub size Medidas de la bañera mm | Estensibilità Verstellbarkeit Adjustability Extensibilidad mm | Misura Maß Size Medidas mm | | Misura Maß Size Medidas mm | |
|---|--|---|---|--|-----|--|--|
| | | | | A | B | | |
| Antina per vasca a 1 anta* 1-teilige Klappwand* Single pivoting bathscreen* Hoja para bañera 1 elemento* | 0001 LK - L/R | 700 | 708 - 733 | | | min. 665 | |
| | 0002 LK - L/R | 750 | 758 - 783 | | | min. 715 | |
| | 0003 LK - L/R | 800 | 808 - 833 | | | min. 765 | |
| | | | | | | | |
| Antina per vasca a 2 ante* 2-teilige Klappwand* Double pivoting bathscreen* Hoja para bañera 2 elementos* | 2001 LK - L/R | 700 | 1078 - 1103 | 440 | 650 | min. 665 | |
| | 2002 LK - L/R | 750 | 1128 - 1153 | 440 | 700 | min. 715 | |
| | 2003 LK - L/R | 800 | 1178 - 1203 | 440 | 750 | min. 765 | |
| | | | | | | | |

*Il lato di montaggio da definire nell'ordine (sinistra L - destra R) / Montageseite bei Bestellung definieren (links L - rechts R)
 Define the assembly side when ordering (left L - right R) / Lado de la asamblea se indican en el pedido (izquierda L - derecha R)



LK - L



LK - R



LK

LW-2 Special

LOOK FREE LF + LB

PORTA SOFFIETTO + LATERALE PER VASCA
PENDEL-FALTTÜR + SEITENTEIL FÜR BADEWANNE
BI-FOLD DOOR + SIDE PANEL FOR BATHTUB
PUERTA PLEGABLE + LATERAL PARA BAÑERA



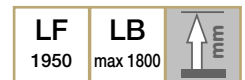

| Descrizione Articolo Artikelbezeichnung Model description Descripción artículo | | Articolo Artikel Model Código | Misura piatto doccia Tassenmaß Tray size Medidas del plato mm | Estensibilità Verstellbarkeit Adjustability Extensibilidad mm | Estensibilità laterale Verstellbarkeit Seitenteil Adjustability side panel Extensibilidad lateral mm | Misura Maß Size Medidas mm A B C | | |
|---|--|--|---|---|--|---|-----|--|
| <p>Porta soffietto Pendel-Falttür Bi-fold door Puerta plegable</p> | 0070 LF | 700 | 668 - 703 | | 580 | 80 | 325 | |
| | 0075 LF | 750 | 718 - 753 | | 630 | 80 | 350 | |
| | 0080 LF | 800 | 768 - 803 | | 680 | 80 | 375 | |
| | 0090 LF | 900 | 868 - 903 | | 780 | 80 | 425 | |
| | 0100 LF | 1000 | 968 - 1003 | | 880 | 80 | 475 | |
| | 0120 LF | 1200 | 1168 - 1203 | | 1080 | 80 | 575 | |
| | <p>Laterale per vasca Seitenteil für Badewanne Side panel for bathtub Pared lateral para bañera</p> | 0015 LB* | 700 - 1000 | | 25 | | | |
| | | | | | | | | |
| | | | | | | | | |
| | | | | | | | | |
| | | | | | | | | |

* Articolo é sempre un fuori misura / Artikel ist immer Sondermaß / article is always special measure / artículo es siempre medida especial

Indicare sempre bordo piatto fino bordo vasca/muretto
Oberkante Duschtasse bis Badewanne/Mauer immer angeben
Indicate always shower tray to bathtub panel/wall
Indique siempre borde superior plato de ducha y bañera/muro



LOOK FREE LE-2

BOX AD ANGOLO PIEGHEVOLE
ECKEINSTIEG KLAPPBAR
FOLDING CORNER ENTRY
CABINA ANGULAR PLEGABLE



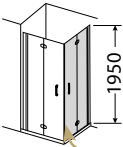

| Descrizione Articolo Artikelbezeichnung Model description Descripción artículo | Articolo Artikel Model Código | Misura piatto doccia Tassenmaß Tray size Medidas del plato mm | Estensibilità Verstellbarkeit Adjustability Extensibilidad mm | Misura centro vetro Mitte Glasmaß Glass size middle Medida vidrio centro mm | Misura Maß Size Medidas mm | | |
|--|--|---|---|---|--|----|-----|
| | | | | | A | B | C |
|  <p>Box ad angolo pieghevole* EckEinstieg klappbar* Folding corner entry* Cabina angular plegable*</p> | 2070 LE | 700 | 665 - 690 | 650 - 675 | 810 | 80 | 325 |
| | 2075 LE | 750 | 715 - 740 | 700 - 725 | 880 | 80 | 350 |
| | 2080 LE | 800 | 765 - 790 | 750 - 775 | 930 | 80 | 375 |
| | 2090 LE | 900 | 865 - 890 | 850 - 875 | 1070 | 80 | 425 |
| | 2100 LE | 1000 | 965 - 990 | 950 - 975 | 1240 | 80 | 475 |
| | 2120 LE | 1200 | 1165 - 1190 | 1150 - 1175 | 1490 | 80 | 575 |

*Usate 2 articoli LE per il box completo / Verwenden Sie 2 x Artikel LE für die komplette Kabine / Use 2 article LE for the complete box / Le rogamos de usar 2 x LE per para la cabina completa

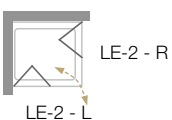

LOOK FREE LE-2 + LW

PORTA SOFFIETTO CON LATERALE
PENDEL-FALTTÜR MIT SEITENTEIL
BI-FOLD DOOR WITH SIDE PANEL
PUERTA PLEGABLE CON LATERAL





| | | |
|---------------------|-------------------|--|
| LE-2 1950 | LW 1950 | |
|---------------------|-------------------|--|

| | | | |
|-------------------------|-----------|-----------|------|
| GH High Glass | SC | GL | 6 mm |
|-------------------------|-----------|-----------|------|

| | | |
|-----------|-----------|--|
| 28 | 05 | |
|-----------|-----------|--|

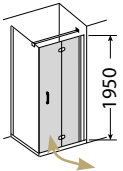
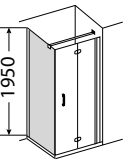
| Descrizione Articolo Artikelbezeichnung Model description Descripción artículo | Articolo Artikel Model Código | Misura piatto doccia Tassenmaß Tray size Medidas del plato mm | Estensibilità Verstellbarkeit Adjustability Extensibilidad mm | Misura centro vetro Mitte Glasmaß Glass size middle Medida vidrio centro mm | Misura Maß Size Medidas mm | | |
|---|--|---|---|---|--|----|-----|
| | | | | | A | B | C |
|  Porta soffietto Pendel-Faltrittür Bi-fold door Puerta plegable | 2070 LE | 700 | 670 - 695 | 655 - 680 | 580 | 80 | 325 |
| | 2075 LE | 750 | 720 - 745 | 705 - 730 | 630 | 80 | 350 |
| | 2080 LE | 800 | 770 - 795 | 755 - 780 | 680 | 80 | 375 |
| | 2090 LE | 900 | 870 - 895 | 855 - 880 | 780 | 80 | 425 |
| | 2100 LE | 1000 | 970 - 995 | 955 - 980 | 880 | 80 | 475 |
| | 2120 LE | 1200 | 1170 - 1195 | 1155 - 1180 | 1080 | 80 | 575 |
|  Laterale con sostegno Seitenteil mit Stütze Side panel with support Pared lateral con soporte | 0001 LW | 700 | 670 - 695 | 655 - 680 | | | |
| | 0002 LW | 750 | 720 - 745 | 705 - 730 | | | |
| | 0003 LW | 800 | 770 - 795 | 755 - 780 | | | |
| | 0004 LW | 900 | 870 - 895 | 855 - 880 | | | |
| | 0005 LW | 1000 | 970 - 995 | 955 - 980 | | | |
| | 0007 LW | 1200 | 1170 - 1195 | 1155 - 1180 | | | |

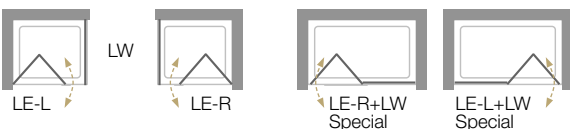

LOOK FREE LK-3

ANTINA PER VASCA A 2 ANTE PIEGHEVOLE
2-TEILIGE KLAPPWAND
DOUBLE PIVOTING BATHTHSCREEN
HOJA PARA BAÑERA 2 ELEMENTOS





High
GLASS



LK-3
1400



GH High Glass SC GL 6 mm

28 05

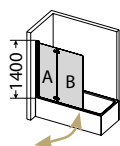
| Descrizione Articolo Artikelbezeichnung Model description Descripción artículo | Articolo Artikel Model Código | Misura vasca Wannenmaß Bathtub size Medidas de la bañera mm C | Estensibilità Verstellbarkeit Adjustability Extensibilidad mm | Misura Maß Size Medidas mm | | | | |
|---|--|--|---|--|-----|--|--|--|
| | | | | A | B | | | |
|  <p>Antina per vasca a 2 ante pieghevole 2-teilige Klappwand Double pivoting bathscreen Hoja para bañera 2 elementos</p> | 3120 LK | 650 min. | 1200 - 1225 | 665 | 550 | | | |
| | | | | | | | | |
| | | | | | | | | |
| | | | | | | | | |
| | | | | | | | | |

